

CC ComfortLine  
Prog S-1-10 V  
100 V IP 40 W



COMFORTLINE PROG  
S-1-10 V 100 V IP 40 W

187251

**Typical Applications**

Built-in in compact luminaires

- Street lighting
- Industrial lighting

	<b>1-10V</b>	

ComfortLine Prog S-1-10 V 100 V IP 40 W

- **DEGREE OF PROTECTION: IP67**
- **SELECTABLE OUTPUT CURRENT VIA OFFLINE PROGRAMMING**
- **DIMMABLE: 1-10 V**
- **MIDNIGHT FUNCTION**
- **VERY LOW RIPPLE CURRENT: < 7%**
- **SURGE PROTECTION: UP TO 6 KV**
- **PREASSEMBLED CONNECTION LEADS**
- **LONG SERVICE LIFE: UP TO 100,000 HRS.**
- **PRODUCT GUARANTEE: 5 YEARS**



## ComfortLine Prog S 100 V 1-10 V IP 40 W

### Product features

- Compact casing shape

### Functions

- Selectable current output via offline programming
- Programmable via USB interface
  - MidNight function
  - Constant Lumen Output (CLO)

### Electrical features

- Mains voltage: 100–277 V  $\pm 10\%$
- Mains frequency: 50/60 Hz
- Pre-assembled connection leads:
  - primary: 3x1 mm<sup>2</sup> (AWG17), length: 300 mm
  - secondary: 2x1 mm<sup>2</sup> (AWG17), 1–10 V and programming: 2x0.35 mm<sup>2</sup> (AWG22), length: 250 mm
- Power factor at full load: > 0.96
- Open circuit voltage (U<sub>max.</sub>): 80 V
- Secondary side switching of LED modules is not allowed.

### Safety features

- Protection against transient main peaks up to 4 kV (between L and N) and up to 6 kV (between L/N and PE)
- Electronic short-circuit protection
- Overload protection
- Overtemperature protection
- Protection against "no load" operation
- Degree of protection: IP67
- Protection class I

### Packaging units

Ref. No.	Packaging unit		
	Pieces per box	Boxes per pallet	Weight g
187251	12	36	490

### Product guarantee

- 5 years
- The conditions for the Product Guarantee of the Vossloh-Schwabe Group shall apply as published on our homepage ([www.vossloh-schwabe.com](http://www.vossloh-schwabe.com)). We will be happy to send you these conditions upon request.

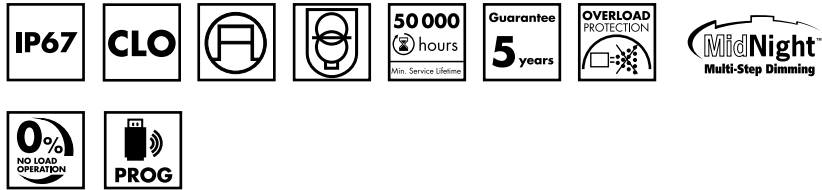
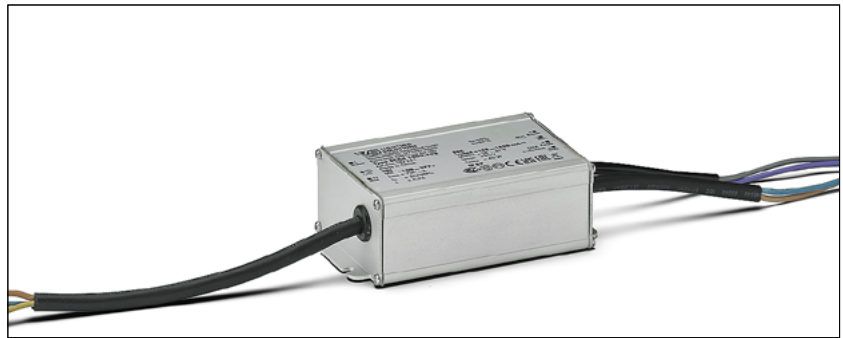

### Applied standards

- EN 61000-3-2
- EN 61347-1
- EN 61347-2-13
- EN 61547
- EN 62384
- EN 55015

### Dimensions

Ref. No.	Casing	Length mm	Width mm	Height mm
187251	M96	117	67	37



### Dimming

1-10V
-------

### Current adjustment

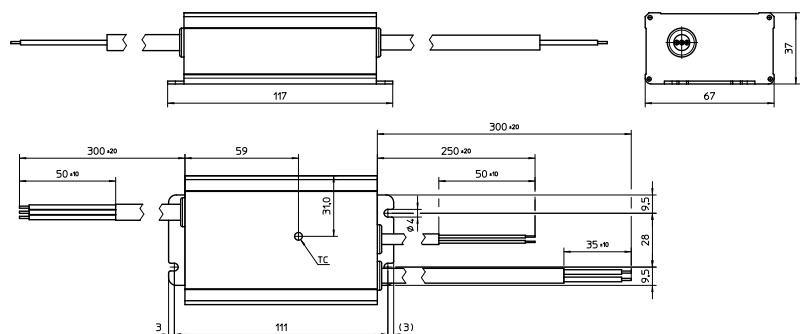

The values contained in this data sheet can change due to technical innovations. Any such changes will be made without separate notification.

## Electrical characteristics

Max. output W	Type	Ref. No.	Voltage 50–60 Hz V $\pm 10\%$	Mains current mA	Inrush current A / $\mu\text{s}$	Current output DC mA ( $\pm 5\%$ )	Factory settings mA	Voltage output DC (V)	THD at full load % (230 V)	Efficiency at full load % (230 V)	Ripple 100 Hz %
40	ECXd 1050.582	<b>187251</b>	100–277	497–182	30 / 108	100–1050	700	28–57	5	85.5	< 7

## Maximum ratings

Exceeding the maximum ratings can lead to reduction of service life or destruction of the drivers.

Ref. No.	Ambient temperature range		Operation humidity range		Storage temperature range		Storage humidity range		Max. operation temperature at $t_c$ point °C	Degree of protection
	°C min.	°C max.	% min.	% max.	°C min.	°C max.	% min.	% max.		
All types	-40	+60	10	95	-40	+85	10	95	+75 (tc,wa.)*   +85 (tc,sa.)*	IP67

\* tc,wa.: (tc,warranty) | tc,sa.: (tc,safety)

## Expected service life time

at operation temperatures at  $t_c$  point\*\*

Operation current	Ref. No.	
	All types	
All	65 °C	75 °C
hrs.	100,000	50,000

\*\* Refer to lifetime vs.  $t_c$  curve for further details

## Product label

<b>VS LIGHTING SOLUTIONS</b>		Vossloh-Schwabe Deutschland GmbH		Stuttgarter Straße 61/1, 73614 Schorndorf		Electronic Converter for LED		I <sub>max</sub> = 60°C		+ ■	
■ Brown		<b>Type ECXd 1050.582</b>		Ref.-No. 187251		Made in China		<b>SEC</b>		DIM Purple	
■ N Blue		<b>Un = 100...277~</b>		I <sub>rated</sub> = 105...1050 mA <sup>max</sup>		I <sub>rated</sub> = 28...57 V		U <sub>max</sub> = 80 V		■ Grey	
■ 1/G		I <sub>max</sub> = 700 mA		P <sub>max</sub> = 40 W		SEC		■ Brown		■ Blue	
■ N Blue		f <sub>ni</sub> = 50/60Hz		λ ≥ 0,9%		IP 67		■ Blue		■ Blue	
■ Blue		λ ≥ 0,9%		λ ≥ 0,9%		λ ≥ 0,9%		λ ≥ 0,9%		λ ≥ 0,9%	

The values contained in this data sheet can change due to technical innovations. Any such changes will be made without separate notification.

## Typ. performance graphs for 187251 / Type ECXd 1050.582

### Working area

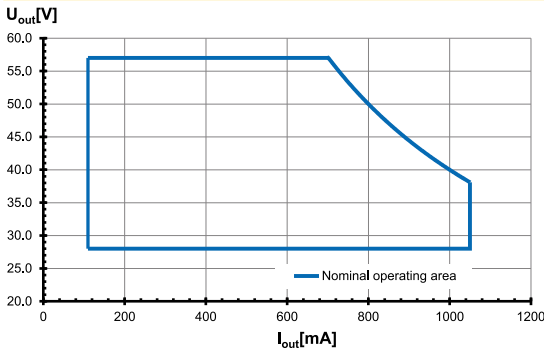

### Efficiency at 230 V

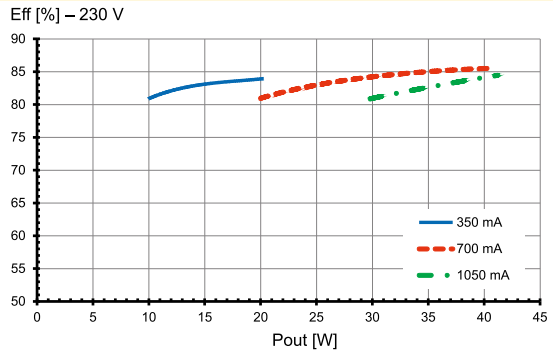

### Power factor at 230 V

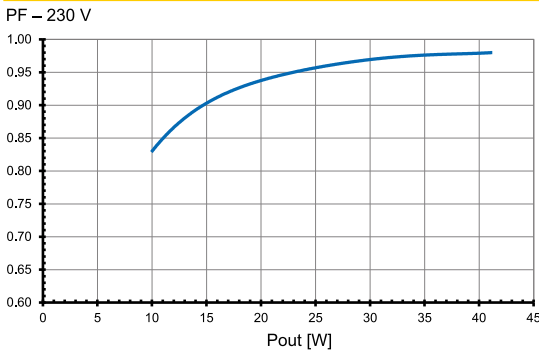

### Total harmonic factor (THD) at 230 V

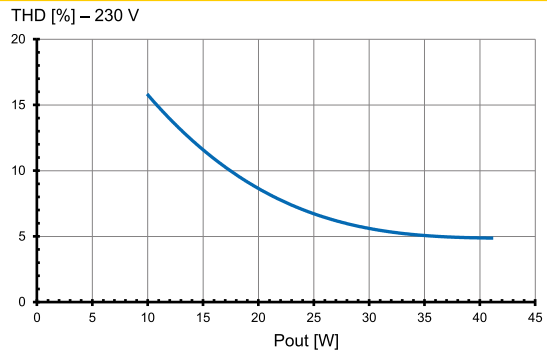

## Typ. performance graphs for 187251 / Type ECXd 1050.582

### Working area

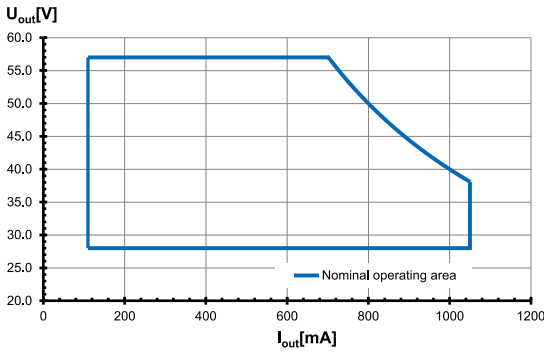

### Efficiency at 120 V

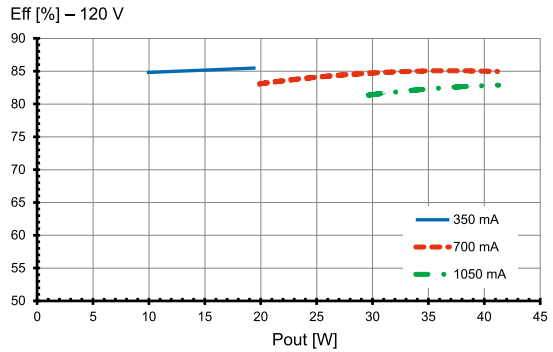

### Power factor at 120 V

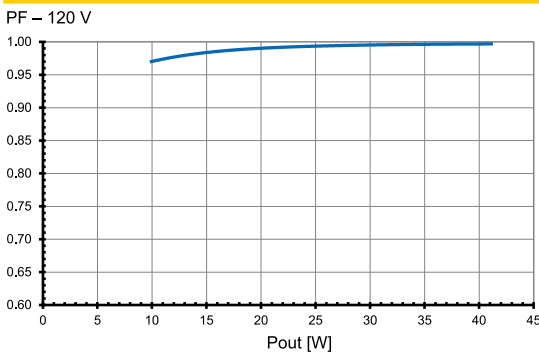

### Total harmonic factor (THD) at 120 V

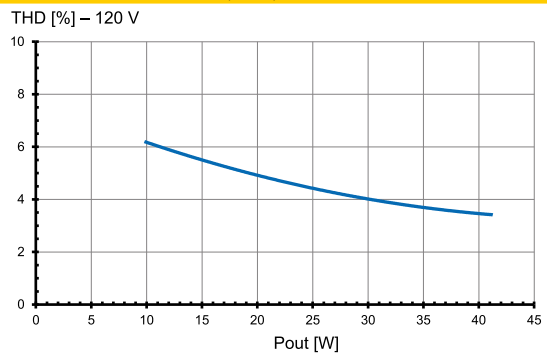

The values contained in this data sheet can change due to technical innovations. Any such changes will be made without separate notification.

## Typ. performance graphs for 187251 / Type ECXd 1050.582

### Working area

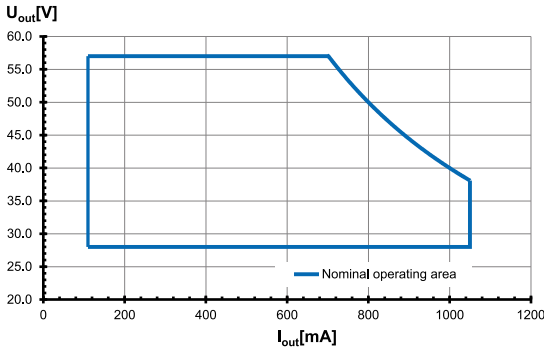

### Efficiency at 277 V

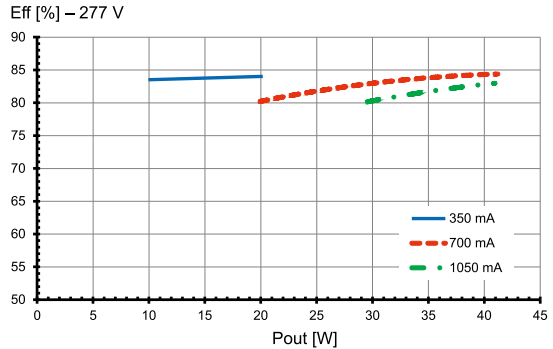

### Power factor at 277 V

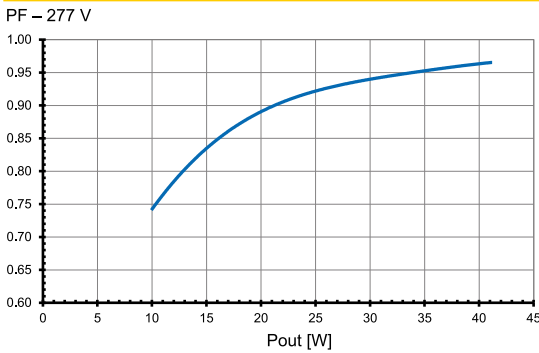

### Total harmonic factor (THD) at 277 V

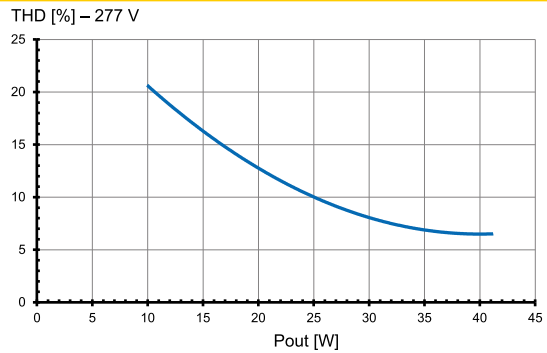

## Load derating

### Load (%) vs. Ambient temperature t<sub>a</sub> (°C)

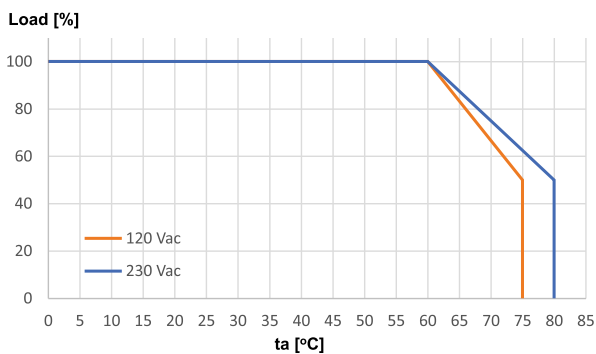

### Load (%) vs. Input voltage U<sub>in</sub> (V AC)

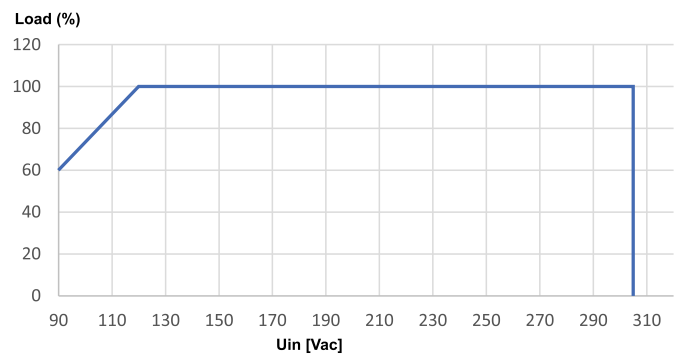

### Lifetime (khours) vs. Casing temperature t<sub>c</sub> (°C)

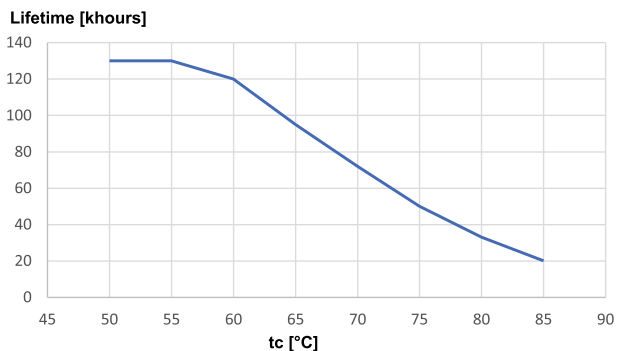

The values contained in this data sheet can change due to technical innovations. Any such changes will be made without separate notification.

## Safety functions

- Transient mains peaks protection:  
Values are in compliance with EN 61547 (interference immunity).  
Surges between L-N: up to 4 kV and between L/N-PE: up to 6 kV
- Short-circuit protection: The control gear is protected against permanent short-circuit with automatic restart function.
- Overload protection: The control gears have overload protection. The output voltage is limited to  $U_{max} < 80V$ .
- Overheating: The control gear has overheating protection. In case of overheating the control gear will reduce the output current.
- No load operation: The control gear is protected against no load operation (open load).
- If any of the above mentioned safety functions will be triggered, disconnect the control gear from the power supply then find and eliminate the cause of the problem.

## System architecture

- You can program the VS ComfortLine Prog S-1–10 V 100 V IP drivers with the VS iProgrammer Streetlight 2 (Ref.No. 187125).
- The LED driver is programmed via USB in a de-energised state.
- The use of the USB programmer is flexible in the production or already in the pre-assembly process. A complex commissioning is not required. The operation and parameterization is done in the simplest way. All operating parameters can be individually programmed and updated.
- The exact description of the programming can be found in the operation manual of the VS iProgrammer Streetlight 2 software.

## MidNight function

Automatic dimming via an integrated timer (no real-time clock). Five independent dimming levels and zones can be set using the iProgrammer Street software.

## Constant lumen output (CLO)

The decrease in the luminous flux of an LED module can be compensated over its entire lifetime via a preprogrammed current curve. This not only ensures stable lighting but also saves energy and increases the lifetime of the LEDs.

## Dimming

- Minimum dimming level: 10% of selected operating current
- 1–10 V source current:

Ref. No.	Source current (µA)	Tolerance (µA)
187251	200	+200



The values contained in this data sheet can change due to technical innovations. Any such changes will be made without separate notification.

## Assembly and Safety Information

Installation must be carried out under observation of the relevant regulations and standards. Installation must be carried out in a voltage-free state (i.e. disconnection from the mains). The following advices must be observed; non-observance can result in the destruction of the LED drivers, fire and/or other hazards.

### Mandatory regulations

- DIN VDE 0100
- EN 60598-1

### Mechanical mounting

- Mounting position: Built-in: Any position inside a luminaire is allowed
- Mounting location: LED drivers are designed for integration into luminaires or comparable devices.
- Degree of protection: IP67  
The driver operate normal under temporary immersion between 0,15 m and 1 m with the condition of the duration time is less than 30 min. and the water temperature does not differ from that of the driver by more than 5 K.
- Clearance: Min. 0.10 m from walls, ceilings and insulation
- Surface: Solid and plane surface for optimum heat dissipation required.
- Heat transfer: If the driver is destined for installation in a luminaire, sufficient heat transfer must be ensured between the driver and the luminaire casing.  
LED drivers should be mounted with the greatest possible clearance to heat sources.  
During operation, the temperature measure at the driver's  $t_c$  point must not exceed the specified maximum value.
- Fastening: Using M4 screws in the designated holes
- Tightening torque: 0.2 Nm

### Electrical installation

- The wire connection should be installed by professional person, reinforced insulation between L/N terminal block and accessible part should be fulfilled.
- The external flexible cable or cord of the LED driver cannot be replaced; if the cord is damaged, the LED driver shall be destroyed.
- During and after installation the connection of input terminal and output terminal should be enclosed to far away from water source.
- Output connection shall be installed by professional person, at least basic insulation corresponding to its max. output voltage should be maintained between current-carrying part of LED modules output and accessible surface or mounting surface after installation.
- Stripped length:  $4 \pm 2$  mm
- Terminal block not included. Installation must be performed by a qualified person.

- Wiring: The mains conductor within the luminaire must be kept short (to reduce the induction of interference). Mains and lamp conductors must be kept separate and if possible should not be laid in parallel to one another.
- Polarity: Please ensure the correct polarity of the leads prior to commissioning. Reversed polarity can destroy the modules.
- Through-wiring: Is not allowed.
- Secondary load: The sum of forward voltages of LED loads has to be within the tolerances which are mentioned in the table "Electrical Characteristics" in this data sheet.
- Wiring diagram:

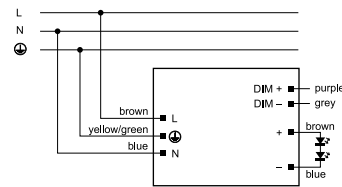

### Selection of automatic cut-outs for VS LED drivers

- Dimensioning automatic cut-outs  
High transient currents occur when an LED driver is switched on because the capacitors have to load. Ignition of LED modules occurs almost simultaneously. This also causes a simultaneous high demand for power. These high currents when the system is switched on put a strain on the automatic conductor cut-outs, which must be selected and dimensioned to suit.
- Release reaction  
The release reaction of the automatic conductor cut-outs comply with VDE 0641, part 11, for B, C characteristics. The values shown in the following tables are for guidance purposes only and are subject to system-dependent change.
- No. of LED drivers  
The maximum number of VS LED drivers applies to cases where the devices are switched on simultaneously. Specifications apply to single-pole fuses. The number of permissible drivers must be reduced by 20% for multi-pole fuses. The considered circuit impedance equals 400 mΩ (approx. 20 m [2.5 mm<sup>2</sup>] of conductor from the power supply to the distributor and a further 15 m to the luminaire).

Type	Ref. No.	Automatic cut-out type and possible no. of VS drivers pcs.					
<b>Automatic cut-out type</b>		B 10 A	B 13 A	B 16 A	C 10 A	C 13 A	C 16 A
ECXd 1050.582	<b>187251</b>	26	34	41	41	53	65

The values contained in this data sheet can change due to technical innovations. Any such changes will be made without separate notification.