

CC LINEAR
DIP SWITCH
DIMMABLE



PRIMELINE DIP SWITCH L-LV
110 V DALI2/1-10 V

186788

Typical Applications

Built-in in linear luminaires for

- Office lighting
- Industrial lighting

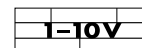

PrimeLine DIP switch L-LV 110 V
DALI2/1-10 V

- **SELECTABLE OUTPUT CURRENT VIA DIP SWITCH**
- **DIMMABLE: DALI (ED. 2), PUSH KEY AND 1-10 V**
- **VERY LOW RIPPLE CURRENT: < 3%**
- **WIDE INPUT VOLTAGE RANGE: 110-277 V**
- **SUITABLE FOR EMERGENCY ESCAPE LIGHTING SYSTEMS ACC. TO EN 50172**
- **SELV**
- **LONG SERVICE LIFE:
UP TO 100,000 HRS.**
- **PRODUCT GUARANTEE: 5 YEARS**



Primeline DIP switch L-LV 110 V DALI2/1–10 V

Product features

- Linear casing shape

Functions

- Selectable current output via DIP switch

Electrical features

- Mains voltage: 110–277 V $\pm 10\%$
- Mains frequency: 50–60 Hz
- DC operation: 176–275 V, 0 Hz
- Push-in terminals: primary 0.5–1.5 mm², secondary 0.2–0.5 mm²
- Power factor at full load: > 0.95
- Open circuit voltage (U_{max.}): 60 V
- Secondary side switching of LED modules is not allowed.

Dimming

- Optional analogue dimming via 1–10 V or DALI interface
- Optional dimming with resistor at 1–10 V interface
- Dimming range: 1 to 100%

Safety features

- Protection against transient main peaks up to 3 kV
- Electronic short-circuit protection
- Overload protection
- Overtemperature protection
- Protection against "no load" operation
- Degree of protection: IP20
- Protection class I
- SELV

Packaging units

Ref. No.	Packaging unit		
	Pieces per box	Boxes per pallet	Weight g
186788	35	40	272

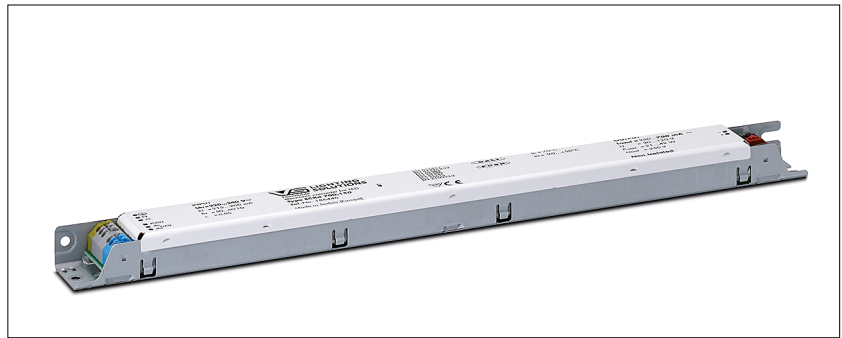

Applied standards

- EN 61347-1
- EN 61347-2-13
- EN 61547
- EN 61000-3-2
- EN 62384
- EN 62386
- EN 55015
- IEC 62386 ed. part 101/102/207



Dimming

Analogue

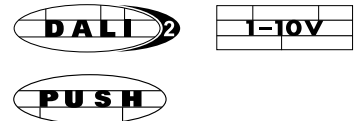

Dimensions

- Casing: M10
- Length: 359 mm
- Width: 30 mm
- Height: 21 mm

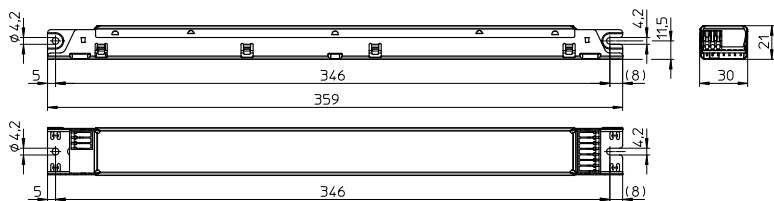

Product guarantee

- 5 years
- The conditions for the Product Guarantee of the Vossloh-Schwabe Group shall apply as published on our homepage (www.vossloh-schwabe.com). We will be happy to send you these conditions upon request.

The values contained in this data sheet can change due to technical innovations. Any such changes will be made without separate notification.

DIP switch settings

Pin 5	Pin 4	Pin 3	Pin 2	Pin 1	Current (mA)
–	–	–	–	–	350
–	–	–	–	ON	400
–	–	–	ON	–	450
–	–	–	ON	ON	500
–	–	ON	–	–	550
–	–	ON	–	ON	600
–	–	ON	ON	–	650
–	–	ON	ON	ON	700
ON	–	–	–	–	750
ON	–	–	–	ON	800
ON	–	–	ON	–	850
ON	–	–	ON	ON	900
ON	–	ON	–	–	950
ON	–	ON	–	ON	1000
ON	–	ON	ON	–	1050
ON	–	ON	ON	ON	1100
ON	ON	–	ON	–	1150
ON	ON	–	ON	ON	1200
ON	ON	ON	–	–	1250
ON	ON	ON	–	ON	1300
ON	ON	ON	ON	–	1350
ON	ON	ON	ON	ON	1400

Typ. performance graphs for 186788 / Type ECXe 1400.317

Working area

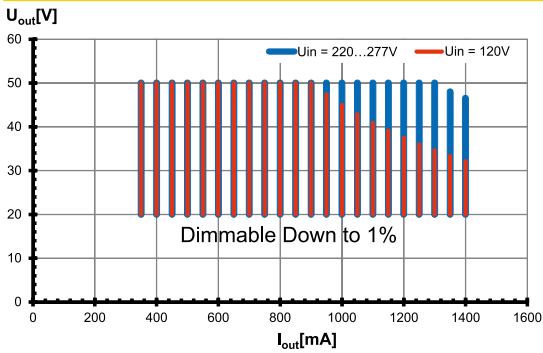

Efficiency

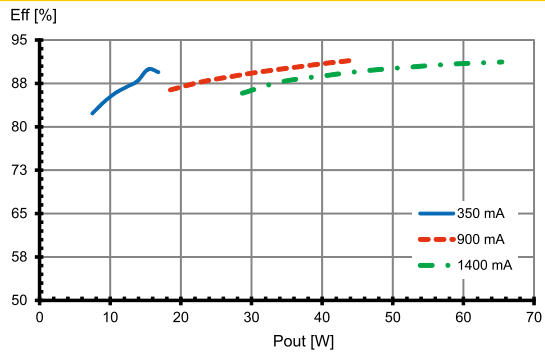

Power factor

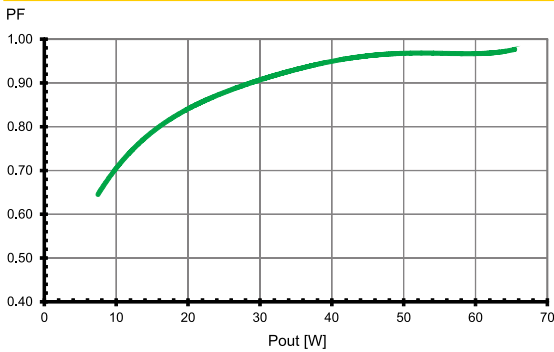

Total harmonic factor (THD)

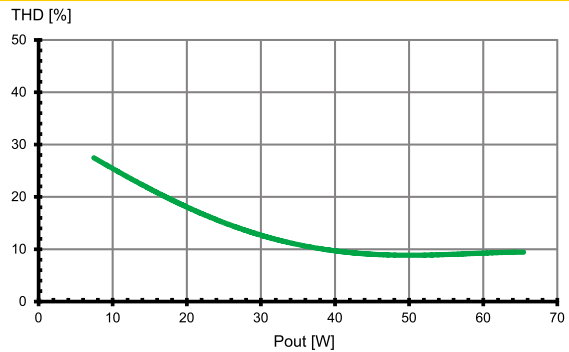

The values contained in this data sheet can change due to technical innovations. Any such changes will be made without separate notification.

Safety functions

- Transient mains peaks protection:
Values are in compliance with EN 61547 (interference immunity).
Surges: up to 3 kV
- Short-circuit protection: The control gear is protected against permanent short-circuit with automatic restart function.
- Overload protection: The control gear only works in range of rated output power and voltage problemfree.
Please check before switch-on mains power supply that the selected LED load is suitable (see Electrical Characteristics on data sheet).
- Overheating: The control gear has overheating protection acc. to IEC 61347-1 C 5e.
- No load operation: The control gear is protected against no load operation (open load).
- If any of the above mentioned safety functions will be triggered, disconnect the control gear from the power supply then find and eliminate the cause of the problem.

DC and emergency lighting operation

- The control gears are suitable for direct voltage operation (DC).
Reliable DC operation is guaranteed if the specified working area of LED driver is maintained.
- DC range: 198–264 V
- Reducing to 176 V: With reduced service life time possible
- Light level at DC operation (EOF₁): 100% (not adjustable)
- DC operation: acc. to EN 60598-2-22 the LED current reduction at high temperature is limited to 50% to nominal current.

PUSH function

- Just one key for dimming and ON/OFF
- Polarity- and phase-independent control
- Control input with large working voltage range
- Suitable for multi-layer control
- After disconnection from the primary voltage the ballast will reproduce the last stored lighting level
- Soft start
- Automatic recognition of DALI and PUSH signals
- PUSH operating voltage ranges:
 - AC: 220–240 V ±10%
 - Failing to observe these working voltage ranges can lead to non-recognition of the signals; exceeding the maximum voltages can lead to the destruction of the data inputs.

- PUSH control signals (key activation):
 - **Short push** (80 ms < t < 460 ms): Is used to switch between ON/OFF lighting states. After the device is switched on, the last selected lighting level is restored and the next dimming direction will be upwards.
 - **Long push** (460 ms < t < 10 s): Is used to dim upwards or downwards; a long push will change the dimming direction. Thus, a long push will reverse the dimming direction until the upper or lower limit is reached. If the light was off, a long push will switch it on and the dimmer will start at the lowest light intensity.
 - **Push to synchronise** (t > 10 s): Light is dimmed to a 30% level and the next dimming direction will be upwards.
 - **Synchronisation:** Any 1-key dimmer that does not feature a central control module (as each ballast will have its own controls) can develop asynchronous behaviour (e.g. children might play with the key). The system will then be out of sync, i.e. some lamps will be on, others off or the dimming direction will differ from lamp to lamp.
Two methods of synchronisation can be used:
 - Push the key for more than 10 seconds, after which the light will be dimmed to a preset level and the next dimming direction will be upwards.
 - Start with a long push of the key so that all lamps are switched on. Follow with a short push to turn the system off. The system will now be resynchronised.

Corridor function

To enable a predefined corridor function profile please follow the instructions below:

- Enable: press the push button for (t > 60 s) to activate the corridor function.
- Disable: disconnect the driver from mains for (t > 5 s) to deactivate the corridor function.
- The fade off time is 30 seconds, light intensity 10%.
- The prolong time is 30 minutes, then off.

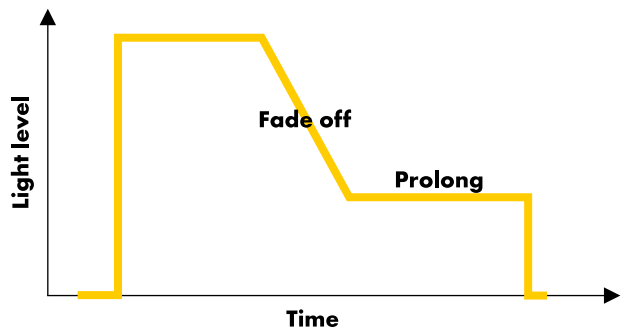

The values contained in this data sheet can change due to technical innovations. Any such changes will be made without separate notification.

Assembly and Safety Information

Installation must be carried out under observation of the relevant regulations and standards. Installation must be carried out in a voltage-free state (i.e. disconnection from the mains). The following advices must be observed; non-observance can result in the destruction of the LED drivers, fire and/or other hazards.

Mandatory regulations

- DIN VDE 0100
- EN 60598-1

Mechanical mounting

- Mounting position: Built-in: Any position inside a luminaire is allowed
Independent application: Drivers are not allowed to use for independent applications
- Mounting location: LED drivers are designed for integration into luminaires or comparable devices.
Installation in outdoor luminaires: degree of protection for luminaire with water protection rate ≥ 4 (e.g. IP54 required).
- Degree of protection: IP20
- Clearance: Min. 0.10 m from walls, ceilings and insulation
- Surface: Solid and plane surface for optimum heat dissipation required.
- Heat transfer: If the driver is destined for installation in a luminaire, sufficient heat transfer must be ensured between the driver and the luminaire casing.
LED drivers should be mounted with the greatest possible clearance to heat sources.
During operation, the temperature measure at the driver's t_c point must not exceed the specified maximum value.
- Fastening: Using M4 screws in the designated holes
- Tightening torque: 0.2 Nm

Electrical installation

- Connection terminals: Push-in terminals for rigid or flexible conductors with a section of 0.5–1.5 mm² (AWG20-16) for primary side and 0.2–0.5 mm² (AWG24-20) for secondary side
- Stripped length: 8.5–9.5 mm
- Wiring: The mains conductor within the luminaire must be kept short (to reduce the induction of interference).
Mains and lamp conductors must be kept separate and if possible should not be laid in parallel to one another.
- PUSH wiring: Several LED drivers can be connected to a single PUSH button. Furthermore, several buttons can also be operated with a single PUSH system as long as the phase assignments (e.g. L1) are identical.
In installations with PUSH function, an asynchronous dimming behaviour can occur. To minimize the risk, VS recommends the max. limit number of 4 LED drivers with one or more PUSH buttons.
The lead length from the push button (n) to the LED driver (n) should not exceed 15 m.
If more than 4 LED drivers are connected to the system, care must be taken to comply with the limitation of cable lengths. In addition, the max. number of LED drivers per circuit breaker should not be exceeded.
- Polarity: Please ensure the correct polarity of the leads prior to commissioning. Reversed polarity can destroy the modules.
- Through-wiring: Is not allowed.
- Secondary load: The sum of forward voltages of LED loads has to be within the tolerances which are mentioned in the table "Electrical Characteristics" in this data sheet.
- Wiring diagram:

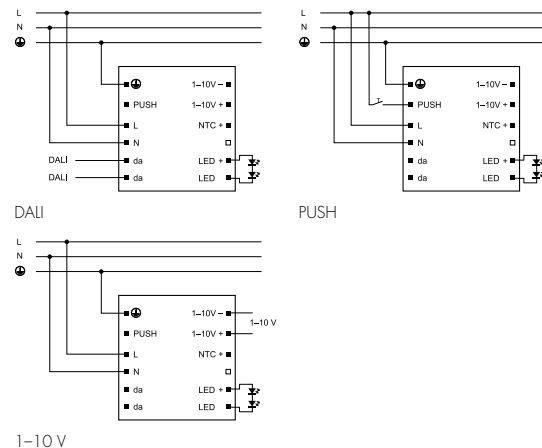

The values contained in this data sheet can change due to technical innovations. Any such changes will be made without separate notification.

Selection of automatic cut-outs for VS LED drivers

- Dimensioning automatic cut-outs
High transient currents occur when an LED driver is switched on because the capacitors have to load. Ignition of LED modules occurs almost simultaneously. This also causes a simultaneous high demand for power. These high currents when the system is switched on put a strain on the automatic conductor cut-outs, which must be selected and dimensioned to suit.
- Release reaction
The release reaction of the automatic conductor cut-outs comply with VDE 0641, part 11, for B, C characteristics. The values shown in the following tables are for guidance purposes only and are subject to system-dependent change.
- No. of LED drivers
The maximum number of VS LED drivers applies to cases where the devices are switched on simultaneously. Specifications apply to single-pole fuses. The number of permissible drivers must be reduced by 20% for multi-pole fuses. The considered circuit impedance equals 400 mΩ (approx. 20 m [2.5 mm²] of conductor from the power supply to the distributor and a further 15 m to the luminaire).

Type	Ref. No.	Automatic cut-out type and possible no. of VS drivers pcs.					
Automatic cut-out type		B 10 A	B 13 A	B 16 A	C 10 A	C 13 A	C 16 A
ECXd 1400.317	186788	19	25	30	19	25	30

- To limit capacitive inrush currents the current carrying capacity of each circuit breaker (fuse) can be increased with the help of our ESB (Ref. No.: 149820, 149821, 149822) inrush current limiters.

The values contained in this data sheet can change due to technical innovations. Any such changes will be made without separate notification.